

CPT-190M-ZSCBZ01

19" Industrial Display

Feature



- EMC Anti-Electromagnetic Interference Standards
- Support high performance temp&voltage customize
- Seamless Full-Screen Panel
- 10-Point Capacitive Touch with Fast, Accurate Response
- Energy Efficient for Continuous Operation



IP65 water proof&dust proof



Various interface



7*24H stable function



Muted heat dissipation design



Wide temp&voltage function

SPEC

Screen Parameters		Touch Parameters	
Size	19"	Touch type	Capacitive (resistance touch optional)
Resolution	1280*1024	Communication Interface	USB agreement
Brightness	250 cd/m2	Touch method	Finger/Capacitive pen
Contrast Ratio	1000:1	Touch Durability	≥50 million touches
Color	16.7M	Transmittance	>87%
Active Display Area	89/89/89/89(Typ.)(CR≥10)	Glass Hardness	> 7H
Viewing Angle	377.3(W)×302.1(H) mm	Glass Material	Chemically tempered glass

I/O Interfaces

Power Input 1	1*DC12V/5521 Socket	HDMI	1*HDMI IN
Power Input 2	1×Wide Voltage 9~36V Jacket (Optional)	DVI	1*DVI IN
Touch Interface	1*USB-B Interface	PC AUDIO	1*PC AUDIO
VGA	1*VGA IN	EARPHONE	1*Headset

Environmental Parameters

Vibration Resistance	GB242 Standard	Operating Temperature	-10°C ~ 60°C
Shock Resistance	EMC EMI Anti-Electromagnetic Interference	Storage Temperature	-20°C ~ 70°C
Backlight Lifespan	50000h	Operating Humidity	≤95% (Non-condensing)
Protection degree	Front panel IP65	Power Consumption	≈20W

Physical Characteristics

Dimensions	429.7*354.5*56.6mm	Material	High-quality aluminum alloy body plus sheet metal structure
Opening Dimensions	75*75mm	Installation Methods	Wall-mounted/desktop/folding base/cantilever installation
Packing dimension		Weight	

Accessories list

Power cord	1*power cord 1.2M	Certificate of conformity	1*Certificate of conformity
Adapter	1*power adapter 1.2M (12V 4A)	Warranty card	1*warranty card

Technical drawing

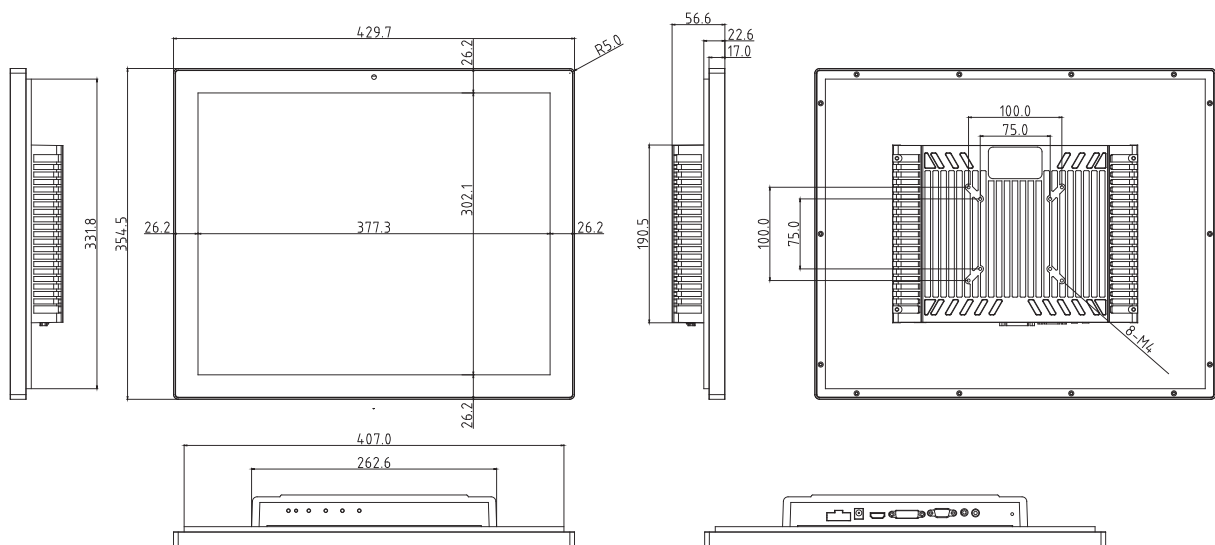

Purchase Information

Product model	CPT-190M-ZSCBZ01
Product Description	19" Industrial Display/Wall-Mounted/Silver/Capacitive Touch/Normal Temperature And Brightness/1280*1024